

advanced **SWAB** transport system

for microbiology

LIQUID MEDIA TRANSPORT SWABS
liquid stuart or liquid amies medium
AGAR GEL TRANSPORT SWABS
with or without charcoal
STUART AGAR GEL
CARY-BLAIR AGAR GEL
PLAIN DRY SWABS



new standard for microbiology swabs

Manufacturer and product conform to highest medical device classification:
Class IIa - Surgically Invasive Transient Use.



Quality, safety and performance is guaranteed, even in the most critical of situations. Class IIa means swabs can be used for sampling body surfaces, body orifices e.g. nose, throat and vagina and deep invasive surgical wounds.

100% traceability



Lot number, expiry date and product description clearly printed on the outside of every swab pack and on every tube. Every unit of production can be identified. Important for quality control, facilitates efficient product recall and correct stock rotation within prescribed dating.



Class IIa manufacturers undergo regular inspections and audits by independent government appointed agencies



Necessary requirement for manufacturers to maintain CE mark accreditation.

Control of manufacturing environment and level of expertise



Manufacturer required to design and maintain good medical device standard production facility. Must also demonstrate correct technical knowledge, skill and expertise. Qualified design team, engineers and microbiologists on site.

Tough bio-burden controls directly influences manufacturing process

Demands for low bio-burden influences how the product is made. In order to comply manufacturers need high technology and automation to ensure product is made in best possible way to meet bio-burden targets.

ISO 9001 & EC93/42 Annex II Controls all product design

From initial concept through to finished product, the system of design and manufacture must conform to new medical device standards.



Manufacturers must have Certified Quality Management System and comply with new manufacturing standards for medical devices.

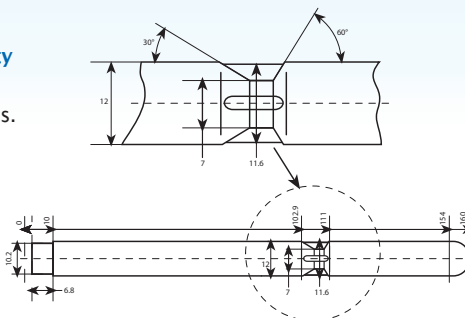



Extra long 13.3cm swab shafts

enable easier access to difficult sampling sites without contaminating the swab handle or the user

Soft rayon swab tips

are inert and non-toxic to micro-organisms and patients

Extra large size polyurethane foam sponge

soaked with liquid transport medium, stays anchored in place, providing a reservoir of moisture for the wab sample



No activation step necessary

no glass ampoules to break or seals to puncture in order to release transport media. Swabs are automatically moistened.

Tamper evident tube seal

maintains product integrity and ensures first time use



Low bioburden

All media contain less than 2 non-viable bacterial cells per 10 high power microscopic fields

Smooth round bottomed tubes

avoid jagged or sharp edges associated with crimped end tubes. No risk of puncturing specimen transport bags. Tubes conveniently fit regular test tube racks facilitating safer transport and easy storage



Double action security cap

maintains product integrity slides over the neck of the swab tube and tightly grips the inside and outside of the tube

Large 5ml depth of agar gel

so swab is always deeply submerged. Gives maximum protection to fastidious bacteria in the sample

Large pre-attached label

for writing sample information and patient data. Printed in 3 languages English, Spanish and French



Tube made from non-breakable polypropylene

to protect the specimen, medical and technical staff handling samples



Venturi Hour Glass tube design enhances performance

eliminates undesirable bubbles and breaks in the deep agar gel column. As the swab is inserted into the tube, air bubbles and breaks in the agar gel are squeezed out.

Complete Range of Liquid & Agar Gel Swabs

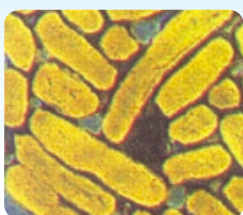

Quality Control

Each lot is stringently tested against a diverse selection of ATCC and NCTC control organisms.

Certificates of Analysis and data available on request.



Minitip Swabs

ENT, Nasopharyngeal and urethral swabs with your choice of medium



Amies Stuart & Cary-Blair Medium

VI-PAK



50 swabs per foil pack
10 packs per case / 500 swabs

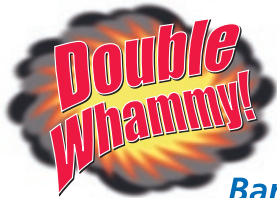

Barrier Plastic and Barrier Foil!

Ultimate product protection and shelf life stability afforded by Copan's unique combination of barrier plastic film swab pouches and barrier outer foil packs. Creates a closed system maintaining stable optimum performance of medium over its long shelf life.



Prevents Media Dehydration - Bugs Always Moist

Moisture, provided by the transport medium, is critical for the survival of bacteria in clinical samples. Vi-Pak's unique combination of metallic foil and barrier plastic film stops liquid evaporation and media dehydration. It prevents hard to detect shrinkage and cracking of agar gel medium and ensures that swabs transported in liquid medium are always moist.

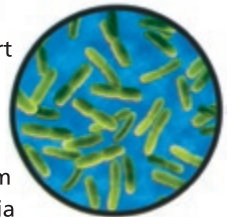

Nitrogen Flushed - Active Packaging

The Vi-Pak concept works continually to maintain the vitality of the medium delivering it to the point of care perfect for maintaining all those difficult and demanding microbes. Nitrogen gas inside the foil pack and the individual plastic film swab pouches work synergistically with sodium thioglycollate in the transport medium to create an ideal Eh potential for Neisseria, Haemophilus, Streptococci, and Anaerobes.

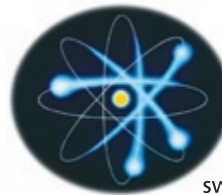

No Superoxide or Free Radicals

Combination of nitrogen rich atmosphere, impermeable barrier swab pouches and foil outer packs prevents the formation of free radicals and superoxide in the transport medium. These components, which can be triggered by the sterilization process or exposure of the medium to UV light, are harmful to the survival of bacteria.



Fantastic Stability - Blocks Oxygen Entry

The metallic foil and plastic film block oxygen entry preventing unwanted oxidation of the transport medium. The integrity of the medium and product performance are extremely stable.

Independent Studies

For free copies of independent published studies documenting the survival of aerobic and anaerobic bacteria in Copan swabs, call or email us today.





**No Glass Ampoules To Break,
No Seals or Barriers to
Puncture. No Dry Swabs!**

5ml Deep Gel Column,
Affords Maximum Protection,
Improves Sample Viability

**Prevents Disintegration or
Breakdown of Gel Column
During Specimen Transport**

Undesirable Bubbles and Breaks
in Gel Automatically Squeezed
Out As Swab is Inserted

**Eliminates Air Pockets
Harmful to Fastidious Bacteria**

Capsulated Environment
Seals and Protects Bacteria



**Unique Venturi Hour Glass Tube
Design Enhances Performance**

Optimizes Moisture Control

**Amies medium available with
or without charcoal plus Stuart
and Cary-Blair medium**

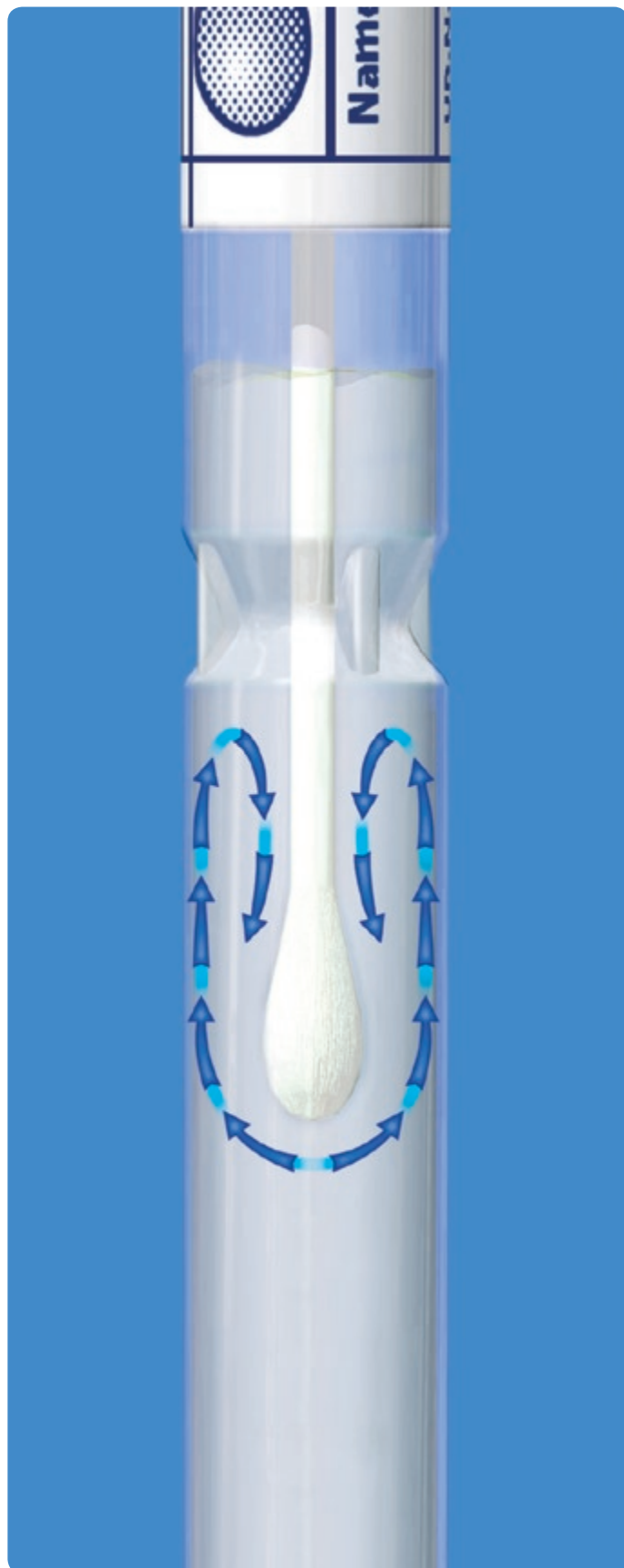
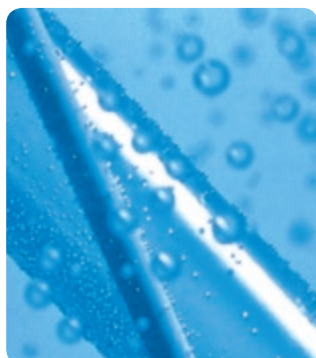

No Bubbles-No troubles!

**Stringent QC of Raw Materials and Finished
Product Guarantees Performance and Very
Low Level Non-Viable Bacteria.**



Routine performance tests incorporate a diverse selection of bacteria; *Neisseria gonorrhoeae*, *Streptococcus pyogenes*, *Staphylococcus aureus*, *Pseudomonas aeruginosa*, *Haemophilus influenzae*, *Bordetella pertussis*, *Neisseria meningitidis*, *Escherichia coli*, *Bacteroides fragilis*, *Prevotella melaninogenica*, *Clostridium perfringens*, *Campylobacter jejuni*, *Shigella flexneri* and *Yersinia enterocolitica*

fastidious anaerobe transport

Fastidious anaerobe transport swabs

Range of agar gel culture swabs specifically designed to maintain the viability of anaerobic bacteria in clinical swab specimens during transport to the laboratory.

Packed in unique laminated film

Swabs are sealed inside a new and unique plastic film pouch. The film is composed of 5 different types of plastic material sandwiched together.



Oxygen entry blocked

The plastic film acts like a barrier preventing penetration of atmospheric oxygen. Atmosphere inside the package is stabilized during the products shelf life.



Nitrogen gassed

During product assembly the tube and swab package are flushed with nitrogen gas to drive out any atmospheric air.



Tamper evident seal - changes color when opened

Package seal immediately changes color from clear to white as soon as pack is peeled open. Provides visual guarantee of first time use, product sterility and integrity.



Designed for anaerobes

Large 6cm depth of agar gel ensures that the swab is always deeply submerged in medium. A deep gel column combined with a narrow hour glass tube constriction, to reduce surface area available for oxygen penetration, provides the maximum protection for anaerobic bacteria in the sample.

Performance tested using fastidious anaerobes

Product is routinely tested using a variety of fastidious anaerobes to guarantee performance when used correctly.

Test organisms include:

Organism	ATCC#
Fusobacterium nucleatum	25586
Bacteroides levii	29147
Peptostreptococcus anaerobius	27337
Clostridium perfringens	13124
Bacteroides fragilis	25285
Fusobacterium necrophorum	25286
Clostridium difficile	9689
Bacteroides thetaiotaomicron	29741
Bacteroides vulgatus	8482
Propionibacterium acnes	6919
Prevotella melaninogenica	25485
Porphyromonas gingivalis	33277

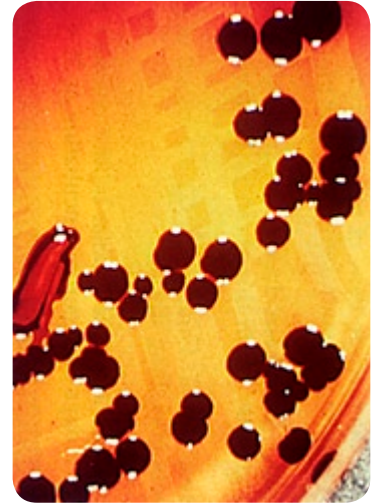

Amies Agar Gel-No Charcoal

Suitable for throat, vaginal, wound and skin swabs.

Catalog No.	Description	Cap Color
108C.USE	Single plastic swab	blue
134C.USE	Double plastic swabs	blue
109C.USE	Single wooden swab	white



All swabs are packaged 50 swabs/box, 10x50 swabs/case



Amies Agar Gel-With Charcoal

Suitable for throat, vaginal, wound and skin swabs.

Catalog No.	Description	Cap Color
114C.USE	Single plastic swab	black
136C.USE	Double plastic swabs	white
115C.USE	Single wooden swab	black



All swabs are packaged 50 swabs/box, 10x50 swabs/case



Mini Tip Amies-No Charcoal

Suitable for ear, nose, throat, eye and male urethral swab sampling. The narrow dimension of the swab shafts and small tip provides a more practical device for some pediatric swab sampling.

Catalog No.	Description	Cap Color
110C.USE	Regular aluminum wire	orange
124C.USE	Soft aluminum wire	green
190C.USE	Flexible twisted wire	blue

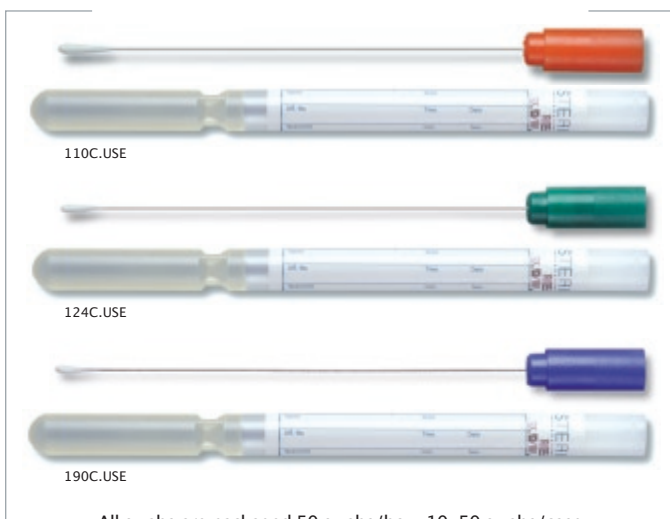

All swabs are packaged 50 swabs/box, 10x50 swabs/case

Mini Tip Amies-With Charcoal

Suitable for ear, nose, throat, eye and male urethral swab sampling. The narrow dimension of the swab shafts and small tip provides a more practical device for some pediatric swab sampling.

Catalog No.	Description	Cap Color
116C.USE	Regular aluminum wire	orange
125C.USE	Soft aluminum wire	green
192C.USE	Flexible twisted wire	blue

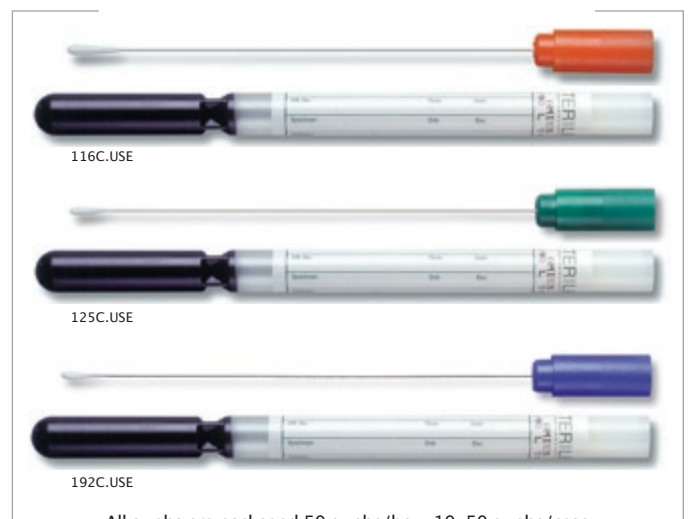

All swabs are packaged 50 swabs/box, 10x50 swabs/case

Stuart Agar Gel Medium

Suitable for throat, vaginal, wound and skin swabs.

Catalog No.	Description	Cap Color
111C.USE	Single plastic swab	blue
135C.USE	Double plastic swabs	blue
112C.USE	Single wooden swab	white
117C.USE	Single wooden swab	black

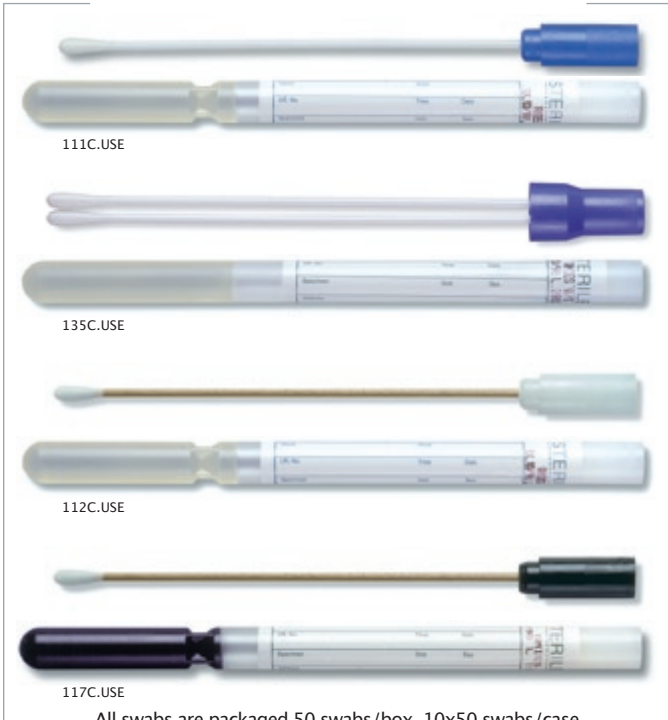

Mini Tip Stuart Agar Gel

Suitable for ear, nose, throat, eye and male urethral swab sampling. The narrow dimension of the swab shafts and small tip provides a more practical device for some pediatric swab sampling.

Catalog No.	Description	Cap Color
113C.USE	Regular aluminum wire	orange

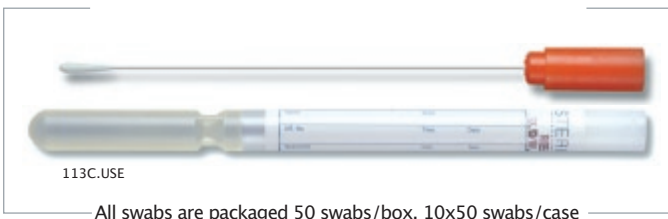

Cary-Blair Agar Gel Medium

Suitable for rectal or fecal samples for enteric pathogens.

Catalog No.	Description	Cap Color
132C.USE	Single Plastic Swab	red

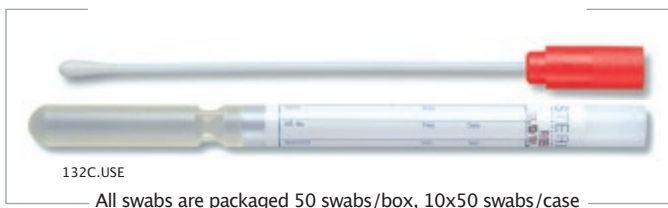

Virus Transport Swabs

Liquid virus transport medium is contained into the sponge deposited in the tube bottom. Very easy to use, this swab format does not require medium activation.

Catalog No.	Description	Cap Color
147C	Single plastic swab	pink
148C	Regular aluminum wire	pink
149C	Flexible twisted wire	pink

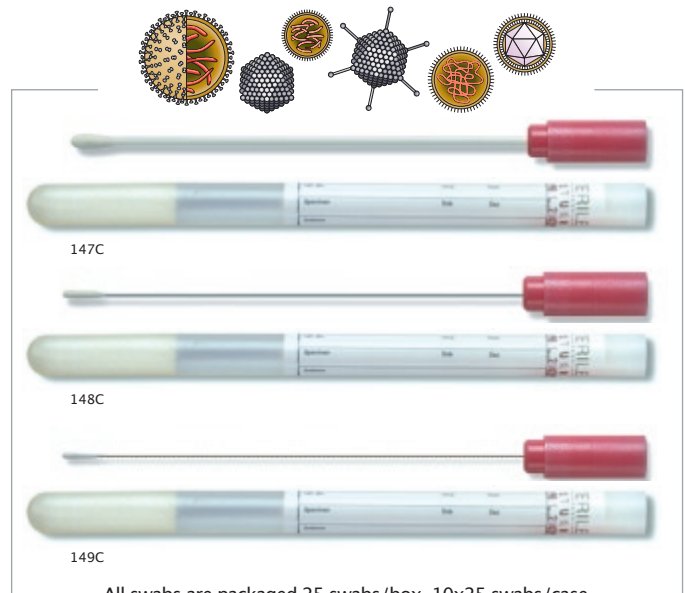

Chlamydia Transport Swabs

Liquid Chlamydia transport medium is contained into the sponge deposited in the tube bottom. Very easy to use, this swab format does not require medium activation.

Catalog No.	Description	Cap Color
144C	Single plastic swab	yellow
145C	Regular aluminum wire	yellow
146C	Flexible twisted wire	yellow

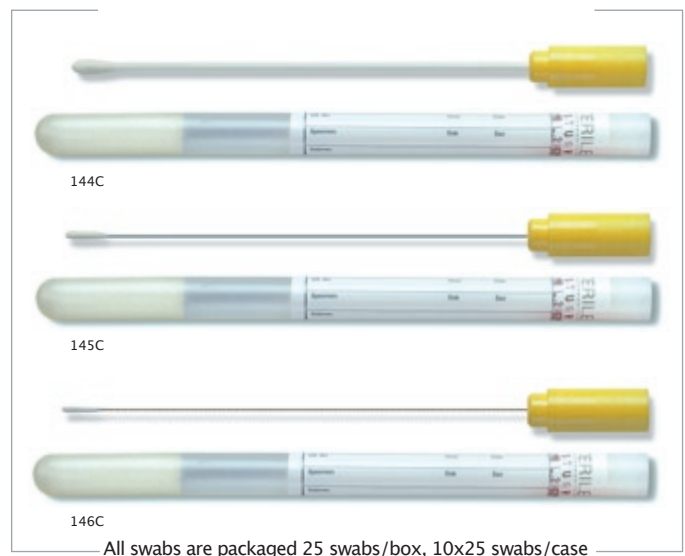

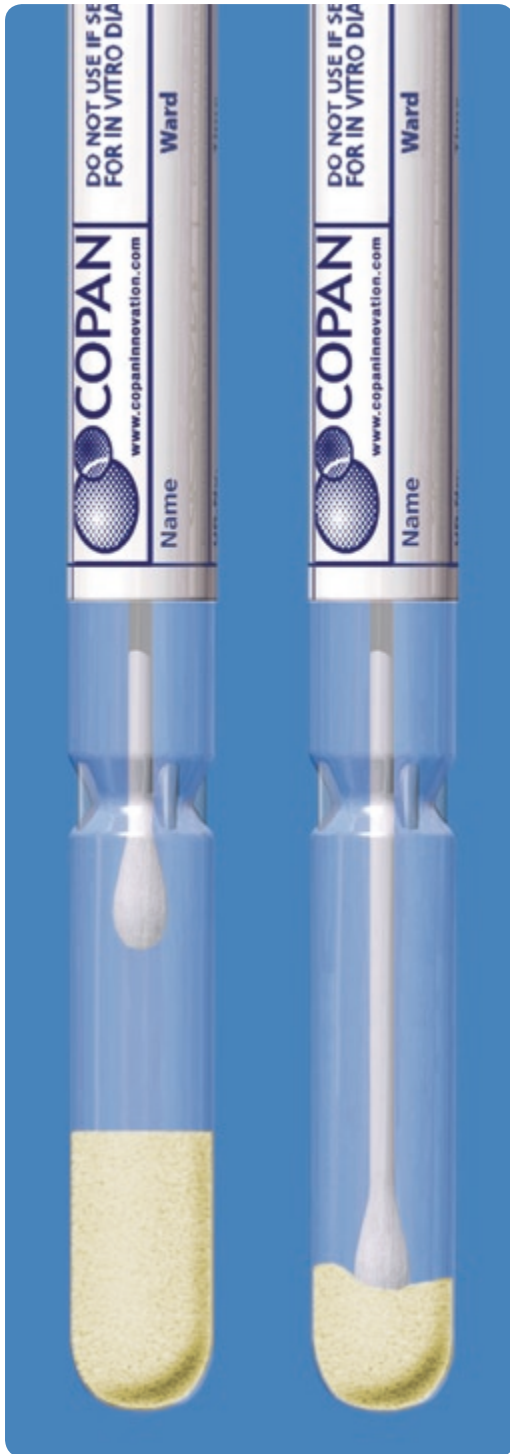

**No Glass Ampoules To Break,
No Seals or Barriers To Puncture**



No Dry Swab Samples!



**Choice of Liquid Stuart or
Superior Liquid Amies Medium**



**Extra Large POLYURETHANE Sponge
Reservoir Inert & Non-Toxic,
Stays Anchored in place**



**Swab Immediately In Direct
Contact With Fluid Filled Sponge**



Its a Slam Dunk!
easy to use specimen collection system

Simply peel open the sterile package and remove the swab. Collect the sample and insert the swab into the tube of medium. This action places the tip of the swab in direct contact with a soft polyurethane foam sponge. The sponge is soaked with 1.0ml of liquid transport medium and acts like a moisture reservoir. As the swab is inserted into the tube the soft sponge yields and compresses down. Liquid medium is drawn immediately into the swab tip by capillary action. The extra large dimensions of the foam sponge means that it holds plenty of medium for both single or double swabs and it stays firmly anchored in place at the bottom of the tube. The sponge design will not slide or fall out during use.

Liquid Stuart Medium	
Sodium Glycerophosphate	10.0g
Calcium Chloride	0.1g
Mercaptoacetic Acid	1.0ml
Distilled Water	1 litre
Liquid Amies Medium	
Sodium Chloride	3.0g
Potassium Chloride	0.2g
Calcium Chloride	0.1g
Magnesium Chloride	0.1g
Monopotassium Phosphate	0.2g
Disodium Phosphate	1.15g
Sodium Thioglycollate	1.0g
Distilled Water	1 litre

Liquid Stuart & Liquid Amies transport medium are designed to support a wide range of bacteria. Amies modified Stuart's original formula by replacing glycerophosphate with an inorganic phosphate buffer. The metabolism of glycerophosphate by coliform organisms and other Gram-negative rods, in Stuart's original formulation, results in proliferation of these organisms from throat, wound and fecal specimens. Amies demonstrated that coliform organisms in throat cultures increased with the duration of delay in transit and the level of ambient temperature. NaCl at 0.3% w/v was discovered by Amies to be optimal for the preservation of Neisseria gonorrhoeae. Calcium and magnesium salts were added in the belief that these ions were of importance in controlling the permeability of the bacterial cells and so contributing to their survival.

Collect specimen and insert swabs into tube



Close cap, swabs are instantly moistened



Complete patient data label

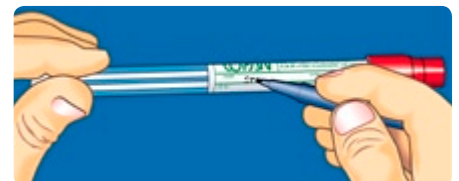

liquid media transport swabs

Liquid Amies Swabs

Suitable for throat, vaginal, wound and skin swabs.

Catalog No.	Description	Cap Color
140C.USE	single plastic swab	white
138C.USE	Double plastic swabs	red



Liquid Stuart Swabs

Suitable for throat, vaginal, wound and skin swabs.

Catalog No.	Description	Cap Color
141C.USE	single plastic swab	white
139C.USE	Double plastic swabs	red



Mini Tip Liquid Amies

Suitable for ear, nose, throat, eye and male urethral swab sampling. The narrow dimension of the swab shafts and small tip provides a more practical device for some pediatric swab sampling.

Catalog No.	Description	Cap Color
142C.USE	Regular aluminum wire	orange
126C.USE	Soft aluminum wire	green
191C.USE	Flexible twisted wire	blue

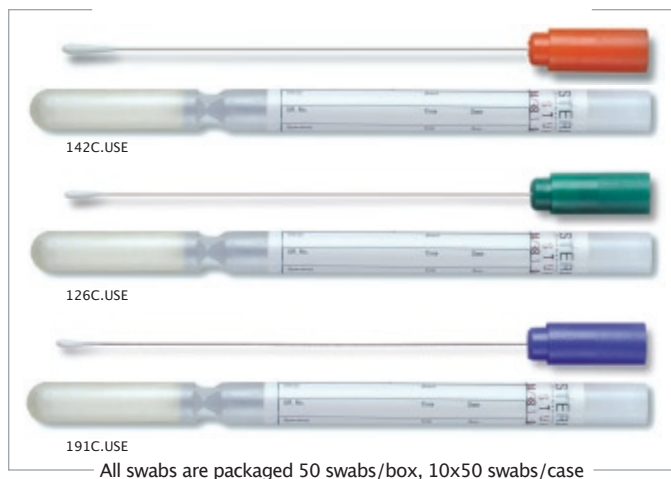

Mini Tip Liquid Stuart

Suitable for ear, nose, throat, eye and male urethral swab sampling. The narrow dimension of the swab shafts and small tip provides a more practical device for some pediatric swab sampling.

Catalog No.	Description	Cap Color
143C.USE	Regular aluminum wire	orange
127C.USE	Soft aluminum wire	green
195C.FE	Flexible twisted wire	blue

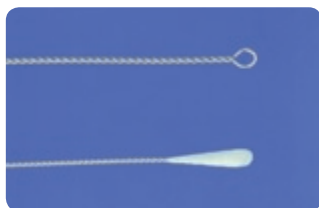
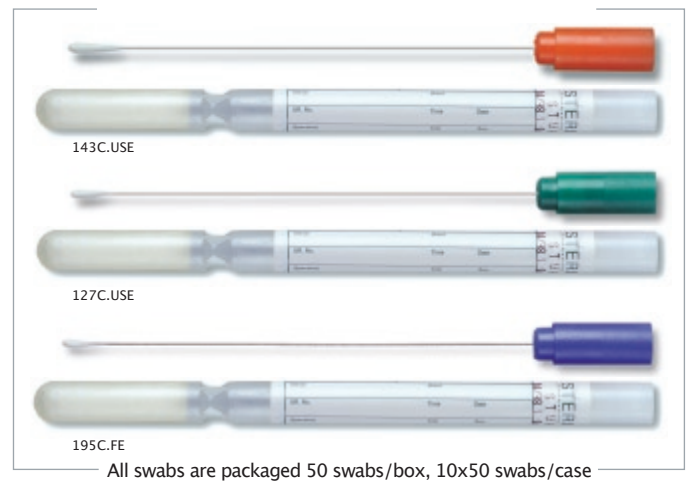

THE NEW M40 TRANSYSTEM
Superior Aerobic and Anaerobic Survival



*Complies with the
NCCLS M40-A Standard at
Room Temperature and 4° C**



Available in:
Amies Agar Gel with Charcoal and
Amies Agar Gel without Charcoal formulas



Plain Dry Swabs In Tubes CLASSIQSwabs™

Sterile plain swabs in labelled tubes.

Code	Applicator	Swab Tip	Color Code
150C	Wood	Cotton	Red
152C	Wood	Cotton/Charcoal coated	Black
154C	Wood	Rayon	White
155C	Plastic	Rayon	White
167C*	Double Plastic	Rayon	White
157C	Plastic	Cotton/Charcoal coated	Black
159C	Plastic	Polyester	Green
160C	Aluminum	Rayon	Orange
162C	Aluminum	Polyester	Yellow
164C	Paper	Cotton	Green
168C	Twisted Wire	Rayon	Blue
184C	Plastic minitip	Rayon	Green
185C	Plastic minitip	Polyester	Red
451C	Wood	Vegetal protein coated	Yellow
456C	Plastic	Vegetal protein coated	Yellow

All swabs are packaged 10x100 swabs/case

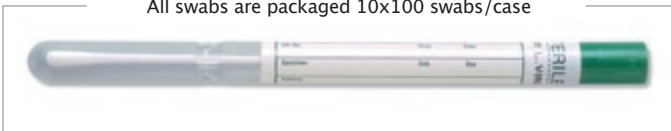

* These swabs are packaged 10x50 swabs/case

Swabs In Peel Pouches CLASSIQSwabs™

Sterile Swabs individually wrapped in peel pouches

Catalog No.	Applicator	Swab Tip
165KS01	Wood	Cotton
167KS01	Plastic	Rayon
164KS01	Plastic	Polyester
170KS01	Aluminum	Rayon
175KS01	Aluminum	Polyester
184CS01*	Plastic minitip	Rayon
185CS01*	Plastic minitip	Polyester
A905BCS01*	Large plastic	Rayon

All swabs are packaged 100 swabs/box, 10x100 swabs/case

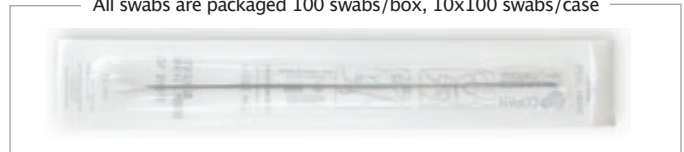

* These swabs are packaged 10x50 swabs/case

Other Copan Products

Code	pack size
706C	Mailing container 26x26 suitable for swab
706CCA	Mailing container 26x26 suitable for swab with absorbing paper



Copan Italia S.p.A.

Via F. Perotti, 10, 25125 Brescia, Italy
Tel: +39 030 268 7211
Fax: +39 030 268 7250
Email: customer-care@copanitalia.com

Copan Diagnostics Inc.

26055 Jefferson Ave, Murrieta, California 92562
Toll Free: (800) 216-4016
Tel: (951) 696-6957 • Fax: (951) 600-1832
Email: info@copanusa.com

